

Parts Diagram 部件名稱

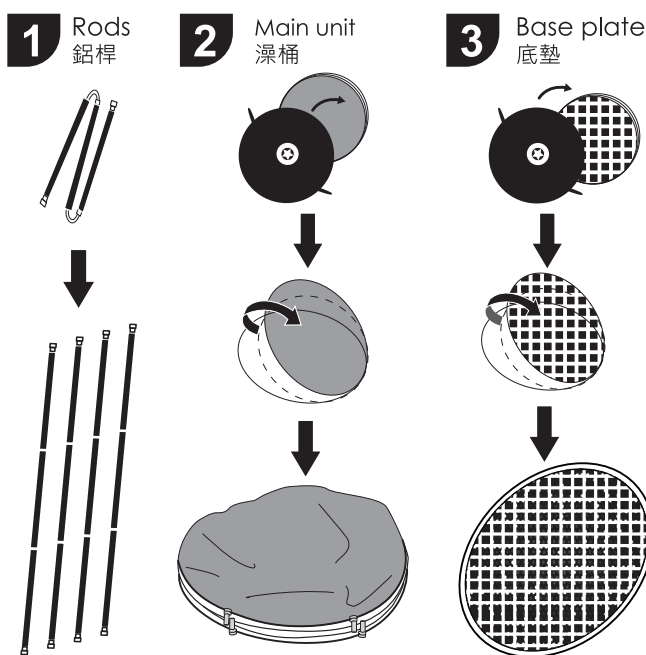

Assemble Preparation 組裝前置作業



Precautions 注意事項

- ◆ Read Manual
請按照說明書進行安裝
- ◆ Keep fire away
遠離火源
- ◆ Avoid sharp objects
避免尖銳物體
- ◆ For adults only
僅提供成人使用
- ◆ Air dry after use
使用後風乾
- ◆ Before use,
close the drain hole
使用前請先關閉排水孔
- ◆ Use on flat ground
請在平坦地面使用

How to Use 如何使用

- 1** Put the base plate into the main unit
將底墊放入澡桶內部

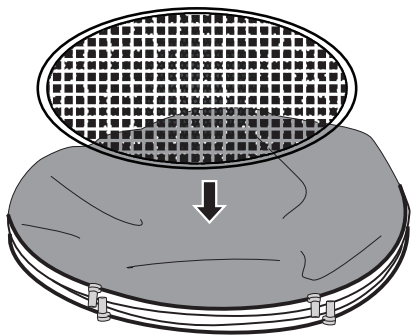

- 2** Insert the rod through the rod pocket and buckle the clamp at the bottom
穿入鋁桿並扣入底部扣件

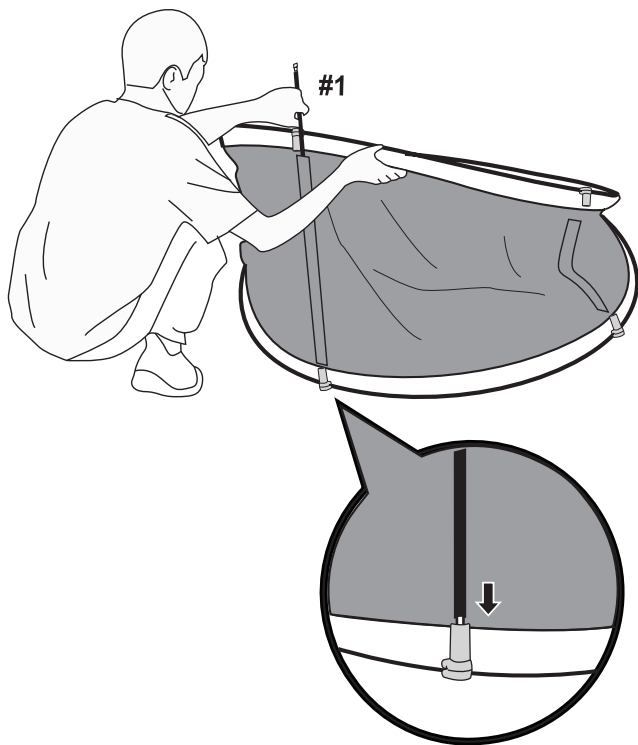

- 3** Follow the previous step,
Install another 3 rods
依照上一步驟穿入另外 3 根鋁桿

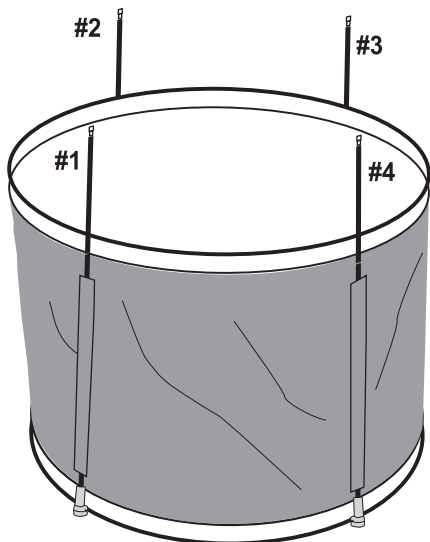

- 4** Put the stool in, and go in
放入凳子，跨入澡桶

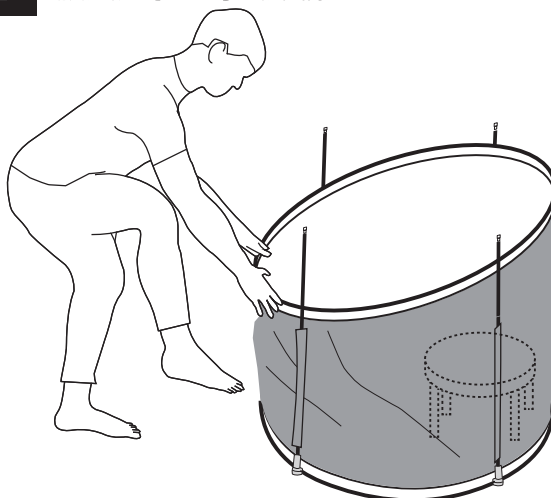

- 5** Buckle the clamp at the top
將鋁桿扣入頂部扣件

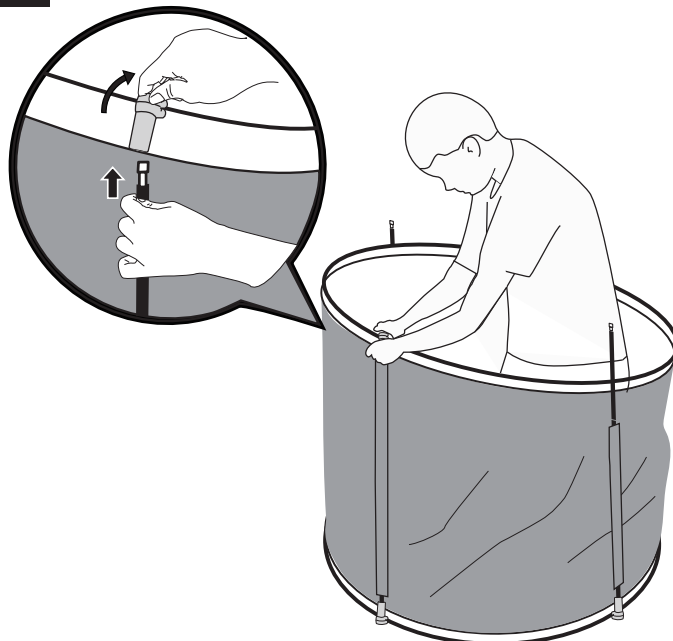

- 6** Follow the previous step,
buckle another 3 clamps
依照上一步驟將另外 3 根鋁桿扣入頂部扣件，
完成組裝

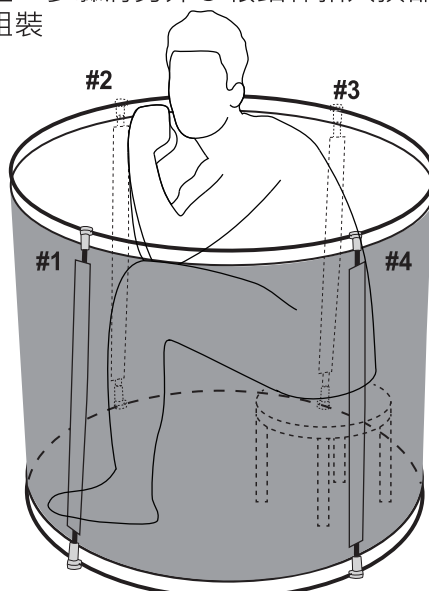

How to Fold 如何拆卸

- 1** unbuckle the clamp at the top
解開頂部4個扣件

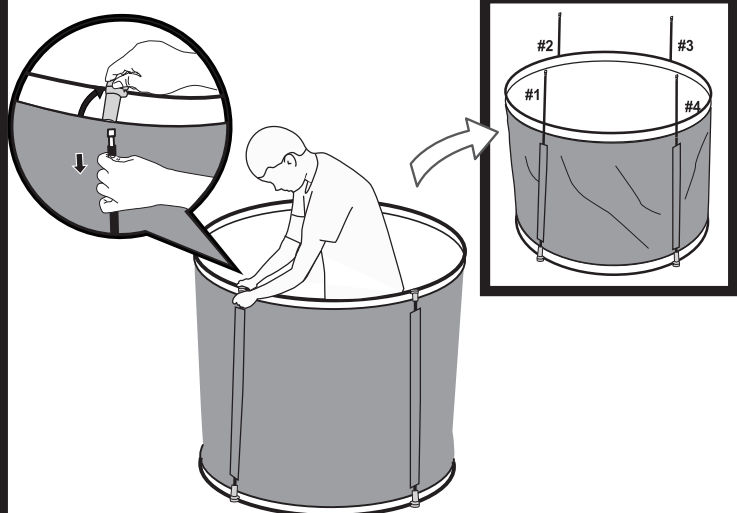

- 2** Push one side down, and go out
壓低一邊鋼圈
跨出澡桶

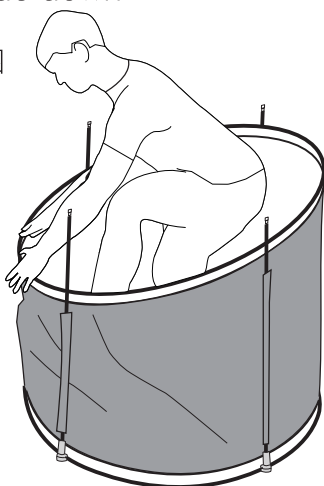

- 3** Take out the base plate from the main unit
從澡桶中拿出底墊

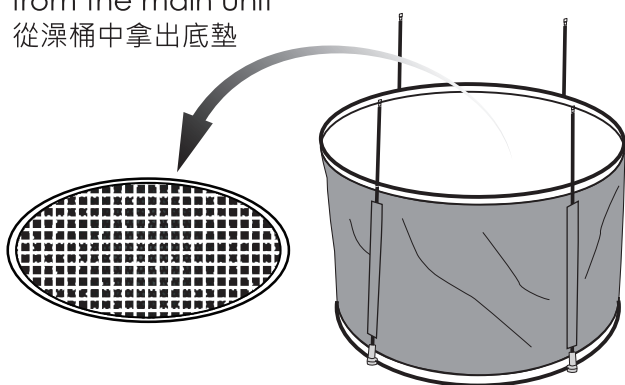

- 4** Unload 4 rods and put them in the rod bag
Dry the main unit and lay it flat
抽出4根鋁桿，放入鋁桿袋
並將澡桶擦乾並平放

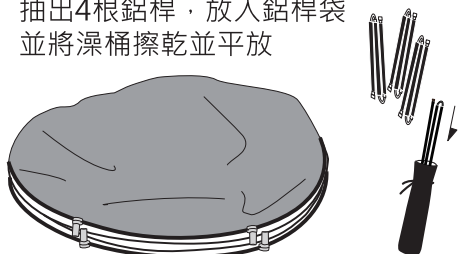

- 5** Hold both sides of the main unit with hands to make it form 45° with the ground
雙手握住澡桶兩側鋼圈，並與地面形成45°

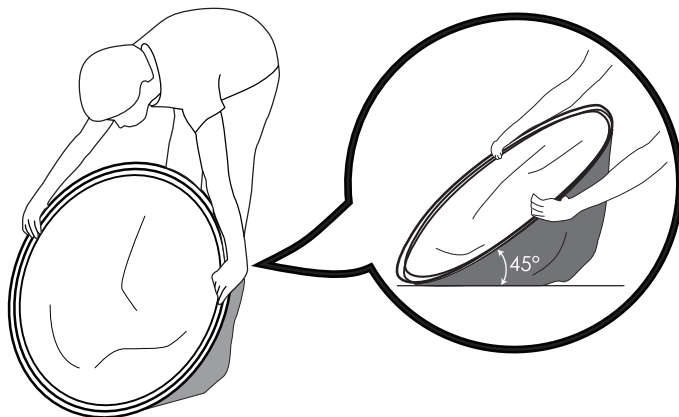

- 6** Let steel rings bending forward and move closer
將鋼圈向前折彎
並向中靠攏

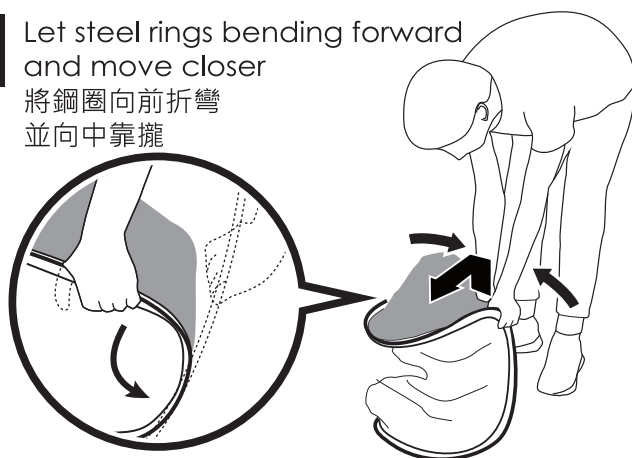

- 7** One side up and the other side down, and hold it with one hand
將鋼圈一上一下靠攏，並用一手握住

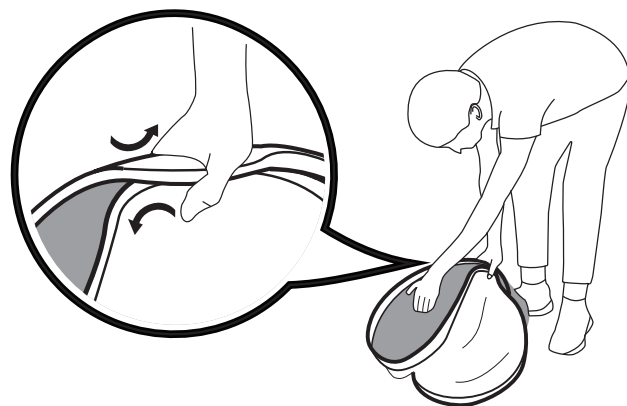

- 8** With the other hand, fold the circle as shown in the figure downward and inward
另一手將如圖的圓圈向下內折

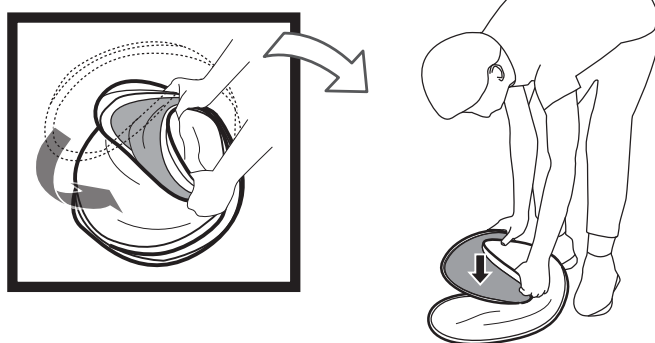

9

Fold the frame and put it in the carry case
收攏邊框，放入攜行包中

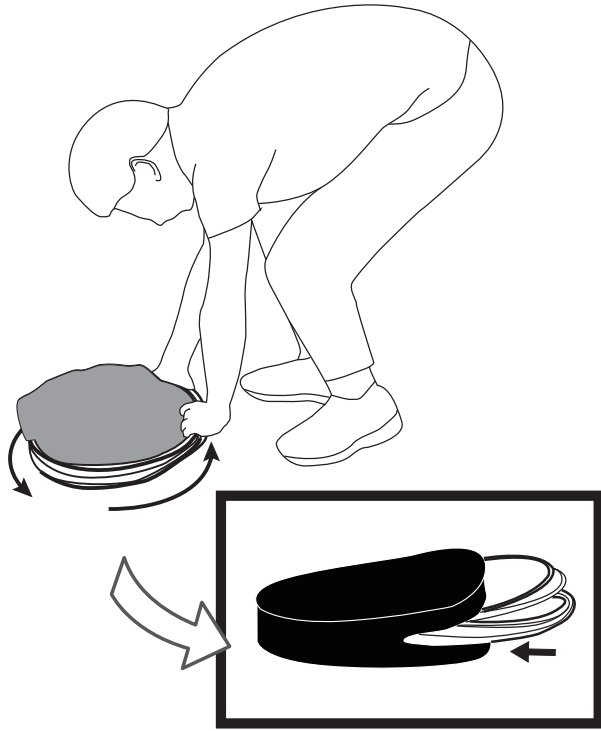
**10**

Follow the previous step.
Fold the Base plate,
and put it in the carry case
依照收納澡桶的步驟摺疊底墊，收入攜行包

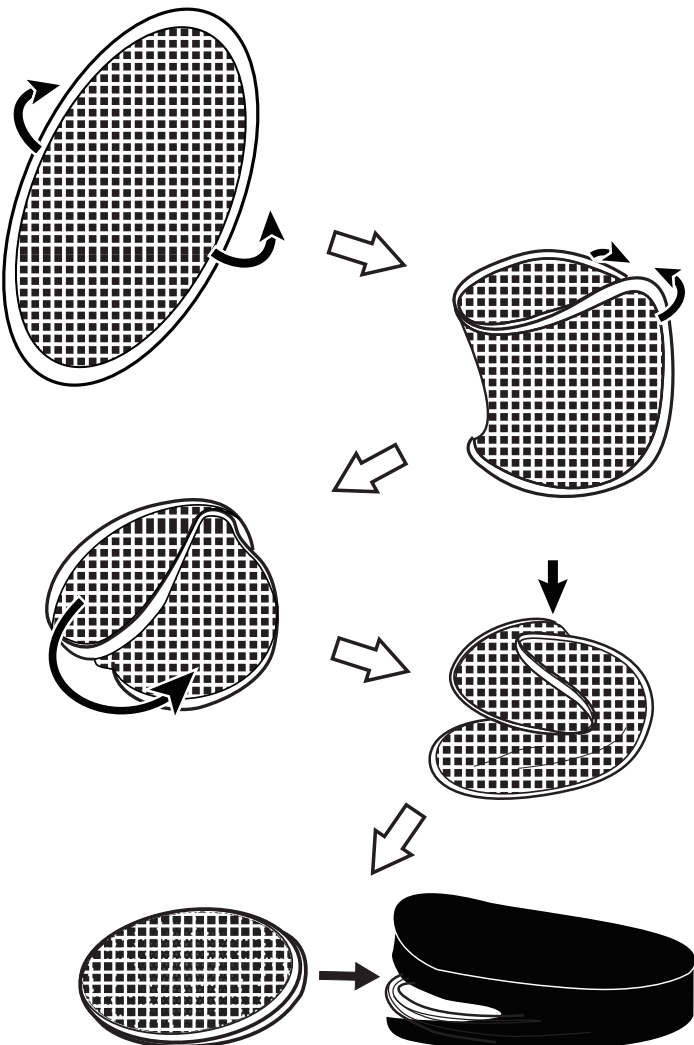

Fold Drain pipe 收納排水管

1

Take 1/4 length and fold in half
取其中一端 1/4 長度對折

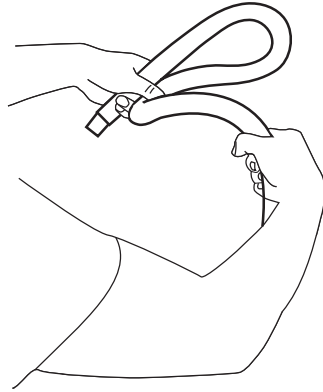
**2**

Wind the drain pipe
將水管纏繞

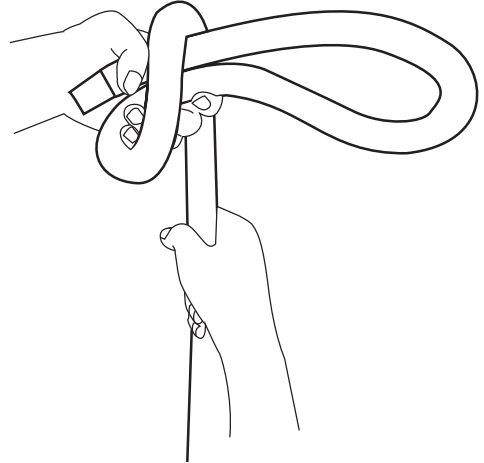
**3**

Tuck the end into the circle
最後將水管頭塞進圓圈裡

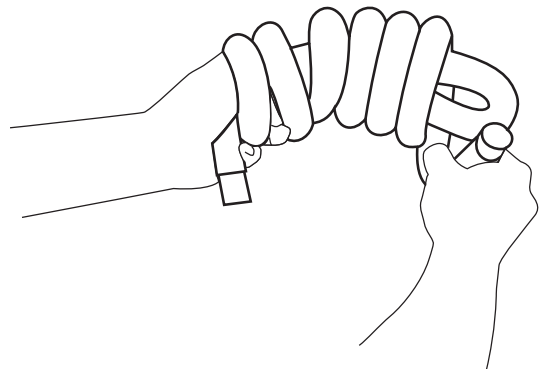
**4**

Finish
完成收納

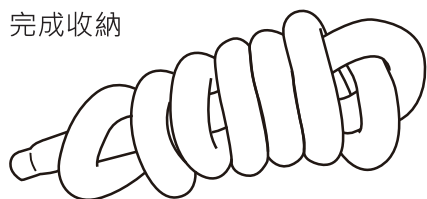

Drain 排水方法

- 1** Find the drain hole at the bottom of the main unit, connect the drain pipe
掀起澡桶底部
找到排水孔
來連接排水管



- 2**
A Tilt the main unit to drain the sewage into the gray water tank
傾斜澡桶
將污水倒入污水桶



OR

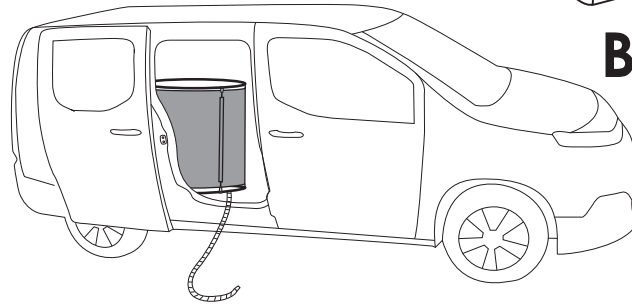

- B** In the car, let the drain pipe drain outward
在車上時
排水管向外排水

Water storage / Bath 儲水/泡澡

- 1** Put on a plastic bag
套上塑膠袋

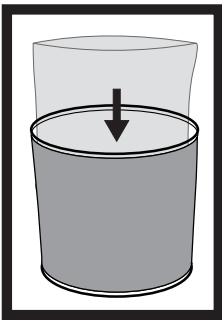

- 3** The plastic bag is sandwiched between the rod and the clamp, and then buckled back
將塑膠袋夾在鋁桿跟扣件之間，再扣回鋁桿

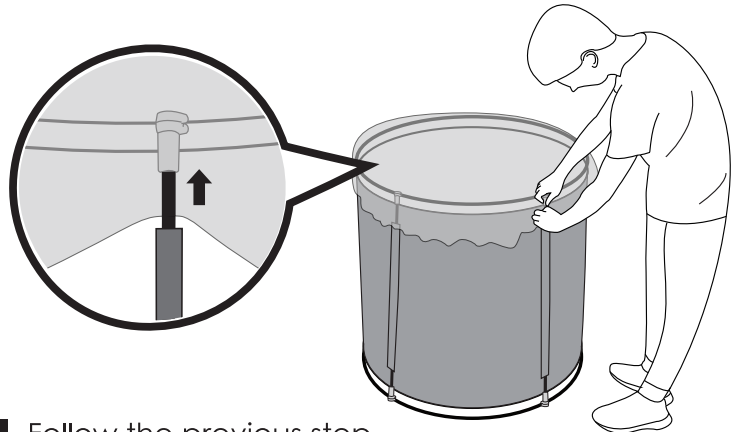

- 2** unbuckle the clamp at the top
將鋁桿從頂部扣件拆出

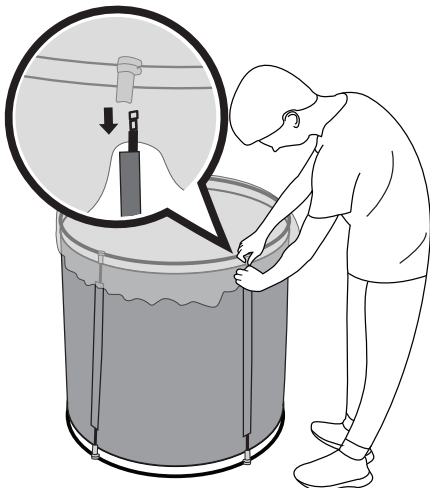

- 4** Follow the previous step.
The plastic bag is sandwiched between another 3 rods and clamps
重複步驟，
將塑膠袋放入另外3根鋁桿間夾住固定

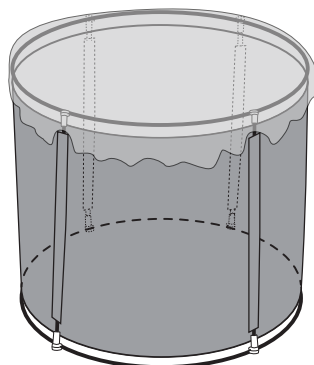

- ◆ Plastic bag size > 135*135cm
塑膠袋尺寸 > 135*135cm
- ◆ This product is waterproof area for the bottom 12cm
本產品防水區域為底部12cm
- ◆ When bathing or storing water, plastic bags are needed
泡澡、儲水使用時，請套上塑膠袋使用
- ◆ The water level does not exceed 2/3 full height
泡澡水位最高不超過三分之二

Insulated Cover 保暖蓋

- 1** Pick up the cover and unzip the zipper
拿起保暖蓋，拉開拉鍊

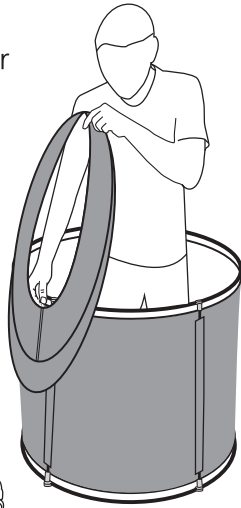

- 2** Put the cover on the body
套到身上

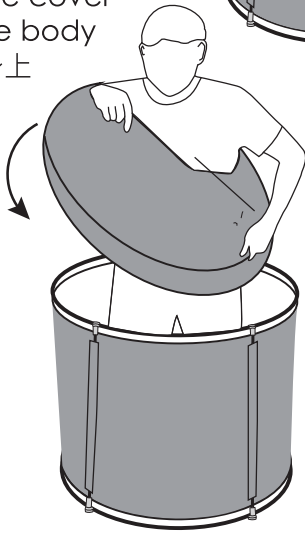

- 3** Cover the cover to the main unit
套上澡桶

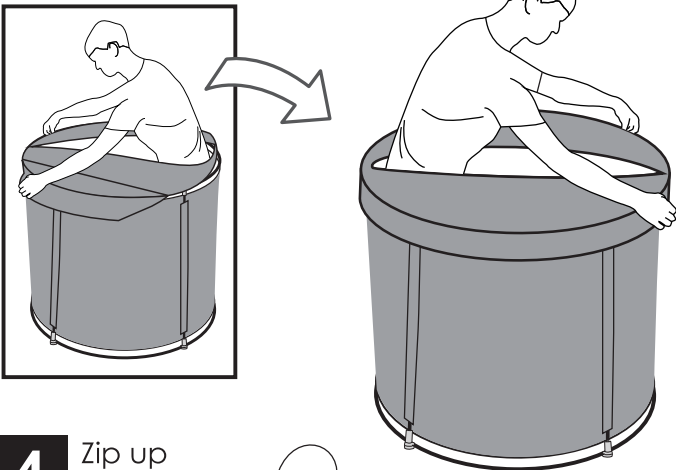

- 4** Zip up
拉上拉鍊

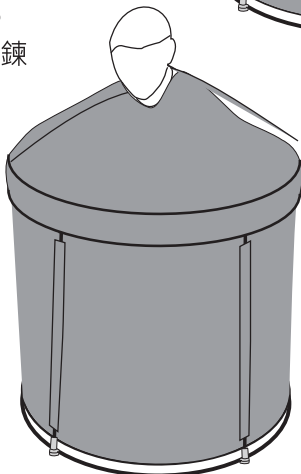

Fold The Cover 收納保暖蓋

- 1** Fold the cover in half to form a semicircle
蓋子對折，呈半圓

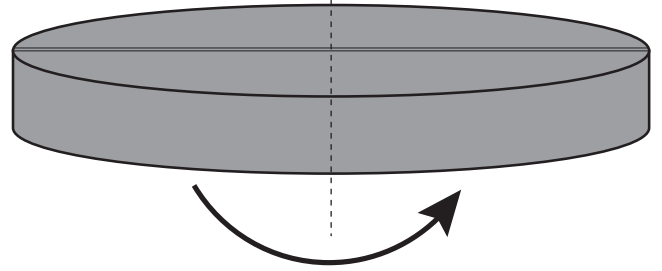

- 2** Fold in half again to make a quarter circle
將半圓再對折，呈 1/4 圓

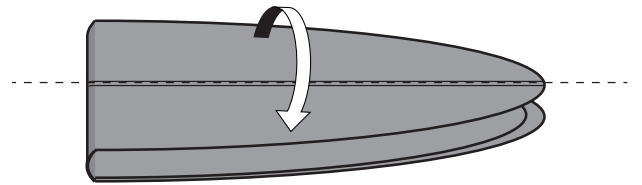

- 3** Fold it in half and make it a long strip
再對折呈長條狀

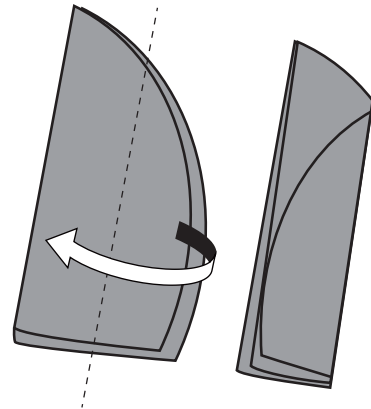

- 4** Roll it up and put it in the carrying bag
捲起來，放入攜行包中

